

HAKKO FM-2022 PARALLEL REMOVER

PARALLEL REMOVER

Instruction Manual



Thank you for purchasing the FM-2022 parallel remover.
Please read this manual before operating the FM-2022.
Keep this manual readily accessible for reference.



CAUTION

- **The FM-2022 cannot function by itself. It must be connected to an FM-202 soldering station.**
- **Specific information can be found in the instruction manual for your FM-202 soldering station.**

TABLE OF CONTENTS

1. PACKING LIST	1
2. SPECIFICATIONS	1
3. WARNINGS, CAUTIONS AND NOTES	2
4. PART NAMES	3
5. SETTING UP THE FM-2022	3
6. OPERATION	4
7. TIP IDENTIFICATION NUMBER	6
8. MAINTENANCE	7
9. TROUBLESHOOTING GUIDE	8
10. PARTS LIST	10
11. WIRING DIAGRAM	11

1. PACKING LIST

- Parallel remover 1
- Heat resistant pad 1

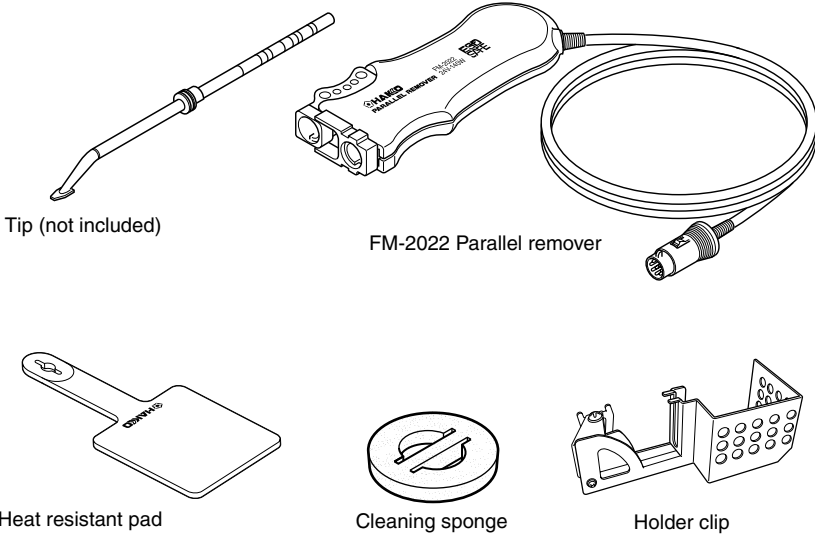

● **Applicable Models**

In order to function, the FM-2022 must be connected to the FM-202 soldering station.

2. SPECIFICATIONS

● **FM-2022 Parallel remover**

Power consumption	140W (24V)
Temperature range	200 – 400°C (400 – 750°F)
Tip to ground resistance	< 2Ω
Tip to ground potential	< 2mV (typical 0.6mV)
Cord assembly	1.2m (4 ft.)
Length, less cord	110mm (w/o tip)
Weight, less cord	53g (Parallel remover only) 11g (SOP 25L Tip only)

* Specifications and design are subject to change without notice.

3. WARNINGS, CAUTIONS AND NOTES

Warnings, cautions and notes are placed at critical points in this manual to direct the operator's attention to significant items. They are defined as follows:



WARNING: Failure to comply with a WARNING may result in injury or death.



CAUTION: Failure to comply with a CAUTION may result in injury to the operator, or damage to the items involved. (One example is given below.)

NOTE: A NOTE indicates a procedure or point that is important to the process being described.



CAUTION

When the power is on, the tip temperature is between 200°C/400°F and 400°C/750°F.

Since mishandling may lead to burns or fire, be sure to comply with the following precautions:

- Do not touch the metal parts near the tip.
- Do not use the product near flammable items.
- Advise other people in the work area that the unit can reach a very high temperature and should be considered potentially dangerous.
- Turn off the power while taking breaks and when finished using the unit.
- Before replacing parts or storing the unit, turn off the power and allow the unit to cool to room temperature.



CAUTION

To prevent damage to the unit and ensure a safe working environment, be sure to comply with the following precautions:

- Do not use the unit for applications other than those specifically described in the instruction manual.
- Do not set the tip temperature higher than 400°C/750°F.
- Do not rap the FM-2022 against the work bench to shake off residual solder, or otherwise subject the iron to severe shocks.
- Do not modify the unit.
- Use only genuine HAKKO replacement parts.
- Do not wet the unit or use the unit when your hands are wet.
- The operating process will produce smoke. Make sure the area is well ventilated.
- Pull on the plug to disconnect the FM-2022 from the station outlet. Do not pull the cord.

4. PART NAMES

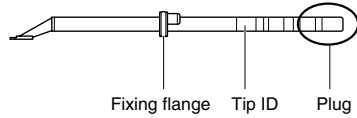
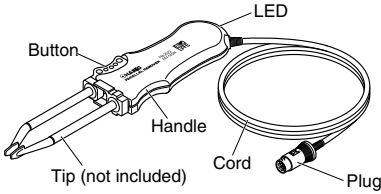

Cleaning sponge

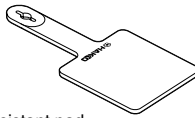

Heat resistant pad

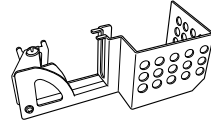

Holder clip

5. SETTING UP THE FM-2022

1. Connector cord

Pass the connector cord through the hole in the heat resistant pad.

2. Iron holder

(Optional, part no. 634-01 or 634-02)

Attach the holder clip to the iron holder no.634-01 or 634-02.

Before tightening the screw, make sure that the two projections of the holder clip are touching the upper wire of the iron holder.

3. Connections

1. Connect the plug to the FM-202.
2. Place the FM-2022 in the iron holder.
3. Plug the power cord into the power supply. Be sure to ground the unit.

NOTE:

This product is protected against electrostatic discharge and must be grounded for full efficiency.

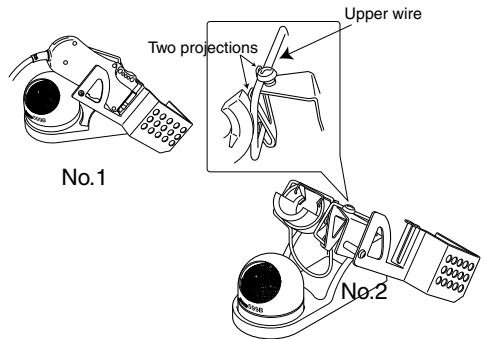
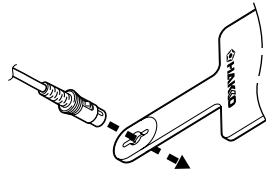

When the plug 'clicks', it is fully inserted.



Receptacle

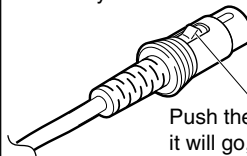

Push the plug in as far as it will go, and try to remove it without pressing the release pin. If it stays in the receptacle it is properly seated.

6. OPERATION

● Controls and displays

Please refer to the FM-202 instruction manual.

NOTE:

If the buzzer sounds three times when the tip is inserted into the process gate, there has been a reading error. Reinsert the tip. If the Tip ID is torn or damaged the process gate will not be able to read it. See the FM-202 manual for instructions on manually entering the Tip ID.

NOTE:

This procedure must be followed EVERY TIME THE STATION IS TURNED ON.

● Displays

1. If tips are in the handpiece, remove them.
2. Turn the power switch ON.
3. The display will show **E-E** and the LED on the connector will flash.
4. Enter Tip ID as follows:
Insert the Tip ID end of one of the tips into the process gate until the buzzer sounds once. Tip ID data are displayed for one second. The display shows **S-E**.

NOTE:

The tips are a set of 2 pieces with the same Tip ID. They must be used together.

5. Inserting the tip:

Hold the head part of the tip with the heat resistant pad and insert the tip into the handpiece. Push until the tip stops. Repeat for second tip.

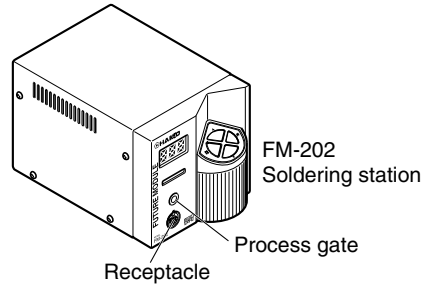

CAUTION:

Refrain from inserting foreign objects, the wrong end of the tip, or incompatible tips into the process gate. Damage may result.

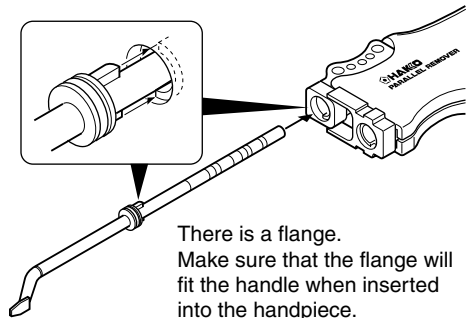
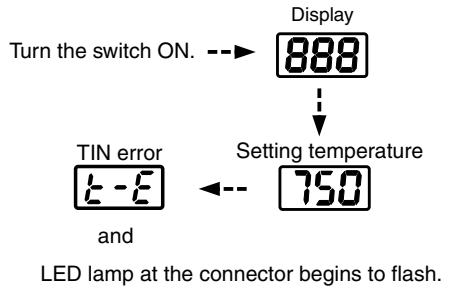

6. When the set temperature is reached, the buzzer sounds and the heater lamp at the lower right of the temperature display starts blinking.

● Operating instructions

1. Set the Temperature

⚠ CAUTION:

Never set the temperature to any value over 400°C (750°F). Doing so may damage the station. Set the temperature according to the type of work to be done.

2. Apply solder or flux

If there is insufficient solder on the PWB, or the soldered area is too small, apply solder or flux to the PWB. Solder may also be applied to the tip.

3. Melt the solder

Place the tip on the soldered part and melt the solder. Confirm that the solder is fully melted. See sketch 'A'.

4. Remove the component

After confirming that the solder is fully melted, lightly squeeze the handpiece to grasp the component and lift to remove the component. See sketch 'B'.

NOTE:

Once the two tips are inserted into the handpiece, heat control begins. Both tips of the set must be inserted or the handpiece will not heat.

⚠ CAUTION:

The tip is very hot during operation. Do not touch the tip or the metal parts near the tip.

⚠ CAUTION:

Very high tip temperatures may damage the printed circuit board, possibly causing the printed pattern to become detached. HAKKO recommends setting the tip temperature below 300°C (572°F) for all normal work. Using the lowest possible effective temperature not only helps protect parts that are sensitive to heat, it also helps protect the tip from deterioration caused by heat.

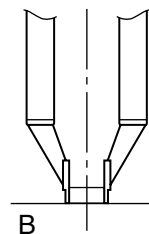
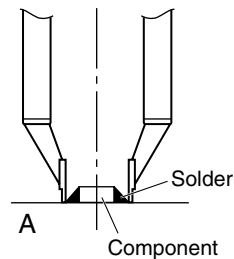

● Control card and changing the temperature setting

Please refer to the FM-202 Instruction manual.

● Replacing the tip

Removing and inserting the tip:

Removing the tip:

Hold the handle and pull the tip out of the handpiece with the heat resistant pad.

Inserting the tip:

Before inserting the tip; Insert the Tip ID end of the tip into the process gate until the buzzer sounds once.

Hold head part and insert the tip into the handpiece. Push until the tip stops.

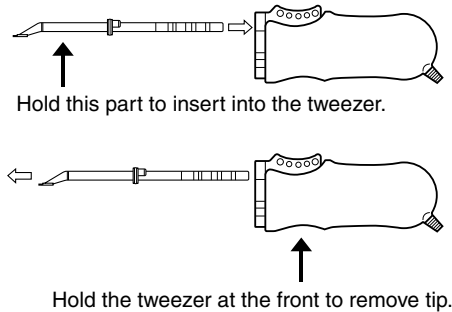

⚠ CAUTION:

The tip can be very HOT. Use the heat resistant pad for handling hot tips, but do not hold the hot portion of the tip, even with the pad, for longer than necessary.

7. TIP IDENTIFICATION NUMBER

Please refer to the FM-202 Instruction manual.

8. MAINTENANCE

● Tip maintenance

Please refer to the FM-202 Instruction manual.

● Checking Procedure

⚠ WARNING:

Unless otherwise directed, carry out these procedures with the power switch OFF and the power UNPLUGGED.

■ Verify the electrical integrity of the heater and sensor

1. Check for a broken heater or sensor

Measure the resistance across this position

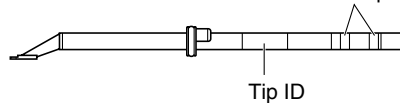

Measure the resistance across the tip as shown. Measure the resistance while at room temperature (15 to 25°C; 59 to 77°F). It should be $8\Omega \pm 10\%$. If the resistance exceeds these limits, replace the tip.

■ Check the grounding line

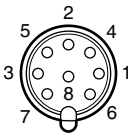

1. Unplug the connection cord from the station.
2. Measure the resistance value between pin 2 and the tip (both tips).
3. If the value exceeds 2Ω (at room temperature), perform the tip maintenance described on P.12 of the FM-202 instruction manual. If the value still does not decrease, check the connection cord for breakage.

■ Checking the connection cord for breakage (Refer to P.11 WIRING DIAGRAM of B side.)

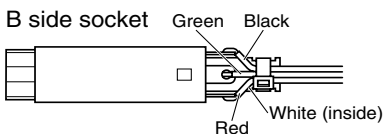

1. Remove the soldering tip and the handle.
 2. Measure the resistance values between the connector and the lead wires at the socket as follows:
Pin 1 – Red Pin 2 – Green
Pin 3 – Black Pin 5 – White
- If any value exceeds 0Ω or is ∞ , replace the FM-2022.

■ **Checking the connection cord for breakage (Refer to P.11 WIRING DIAGRAM of A side.)**

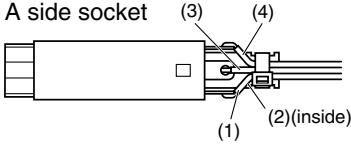

1. Remove the soldering tip and the handle.
2. Measure the resistance values between the connector and the lead wires at the socket as follows:

Pin 7 - (1) Pin 2 - (3)

Pin 4 - (4) Pin 8 - (2)

If any value exceeds 0Ω or is ∞ , replace the FM-2022.

9. TROUBLESHOOTING GUIDE

⚠ WARNING:

Disconnect the power plug before servicing.
Failure to do so may result in electric shock.

● **The tip does not heat up.**

- The sensor error **[5-E]** is displayed.

● **Solder does not wet the tip.**

● **The tip temperature is too high.**

CHECK : Is the power cord disconnected?

ACTION : Connect it.

CHECK : Is the tip inserted properly?

ACTION : Insert the tip completely.

CHECK : Is the connection cord and/or the heater/sensor broken?

ACTION : See the appropriate section of this manual regarding how to check the connection cord and/or the heater/sensor for breakage.

CHECK : Is the tip temperature too high?

ACTION : Set the appropriate temperature.

CHECK : Is the tip contaminated with oxide?

ACTION : Remove the oxide by cleaning the tip on a damp sponge of Hakko 599B tip cleaner.

CHECK : Is the connection cord broken?

ACTION : See "Checking the connection cord for breakage".

CHECK : Is the entered tip identification number correct?

ACTION : Enter the correct value.

● The tip temperature is too low.

● The soldering iron error **E-E** is displayed.

● The low-temperature alarm tolerance error **H-E** occurs frequently.

● Tip ID error **E-E** is displayed.

● Heater terminal short circuit error **HSE** is displayed.

● The tips cannot be closed.

- The tips will not return to the original position.

CHECK : Is the tip contaminated with oxide?

ACTION : Remove the oxide by cleaning the tip on a damp sponge of Hakko 599B tip cleaner.

CHECK : Is the entered tip identification number correct?

ACTION : Enter the correct value.

CHECK : Is the connection cord broken?

ACTION : See “Checking the connection cord for breakage”.

CHECK : Is the FM-2022 plug disconnected?

ACTION : Connect the FM-2022.

CHECK : Is the tip too small for the items to be removed?

ACTION : Use a tip with a large thermal capacity.

CHECK : Is the setting value for the low-temperature alarm tolerance too low?

ACTION : Increase the setting value.

CHECK : Does the tip come off during use?

ACTION : Enter correctly. See section 6, Operation for instructions.

NOTE:

If the buzzer sounds three times when the tip is inserted into the process gate, there has been a reading error. Reinsert the tip. If the Tip ID has been torn or damaged the process gate will not be able to read it. See the FM-202 manual for instructions of manually entering the Tip ID.

CHECK : Is the tip for FM-2022?

ACTION : Turn the power switch OFF and insert the correct FM-2022 tip. Turn the power switch ON.

NOTE:

This error does not display when not entering the Tip ID.

CHECK : Is there a foreign object between the tips?

ACTION : Remove it.

10. PARTS LIST

NOTE:

Replacement parts do not include mounting screws if they are not listed on the description. Screws must be ordered separately.

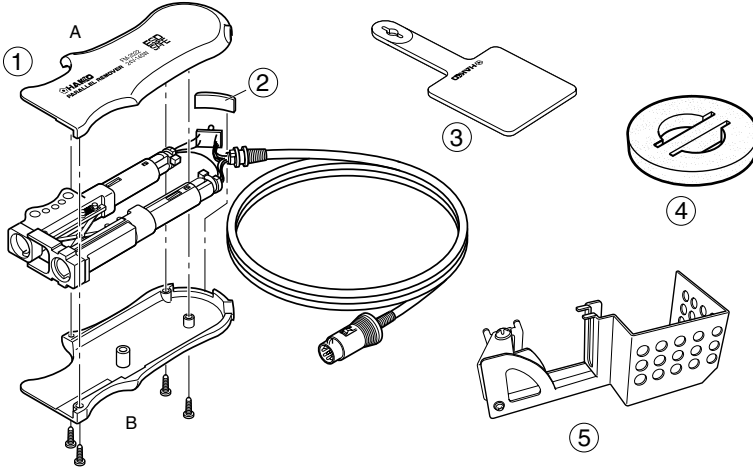

● **Parallel remover**

Item No.	Part No.	Part Name	Specifications
1	B2783	Handle A & B	with screws
2	B2784	LED Holder	
3	B2300	Heat resistant pad	
4	A1495	Cleaning sponge	
5	B2850	Holder clip	with screw

● **Tips**

	Part No.	Part Name	Size A [a]	Shape
CHIP	T8-1001	Tip/CHIP 0.5I	R0.2 mm (0.008 in.)	
	T8-1002	Tip/CHIP 0.5C	1.5 [0.5] mm (0.06 [0.02] in.)	
	T8-1003	Tip/CHIP 1L	1 mm (0.04 in.)	
	T8-1004	Tip/CHIP 2L	2 mm (0.08 in.)	
SOP	T8-1005	Tip/SOP 6L	6 mm (0.24 in.)	
	T8-1006	Tip/SOP 8L	8 mm (0.31 in.)	
	T8-1007	Tip/SOP 10L	10 mm (0.39 in.)	
	T8-1008	Tip/SOP 13L	13 mm (0.51 in.)	
	T8-1009	Tip/SOP 16L	16 mm (0.63 in.)	
	T8-1010	Tip/SOP 20L	20 mm (0.79 in.)	
	T8-1011	Tip/SOP 25L	25 mm (0.98 in.)	
	T8-1012	Tip/SOP 18L	18 mm (0.71 in.)	

11. WIRING DIAGRAM

A side socket

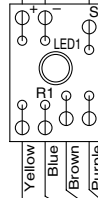
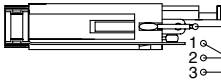

P.W.B./LED

B side socket



Green
Black
Red
White

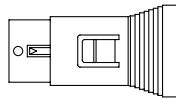

HAKKO CORPORATION

HEAD OFFICE

4-5, SHIOKUSA 2-CHOME, NANIWA-KU, OSAKA, 556-0024 JAPAN

TEL:+81-6-6561-3225 FAX:+81-6-6561-8466

<http://www.hakko.com>

AMERICAN HAKKO PRODUCTS, INC.

28920 N. AVENUE WILLIAMS VALENCIA CA 91355, U.S.A.

TEL: (661) 294-0090 FAX: (661) 294-0096

Toll Free (800)88-HAKKO www.hakkousa.com

4 2 5 5 6