

Thank you for purchasing the HAKKO FR-870 Preheater.
Please read this manual before operating the HAKKO FR-870.
Keep this manual readily accessible for reference.

1. PACKING LIST AND PART NAMES

Please check to make sure that all items listed below are included in the package.

HAKKO FR-870	1	Power cord	1
Thermocouple	1	Instruction Manual (abridged version)	1
Heater lamp (For spare)	1		

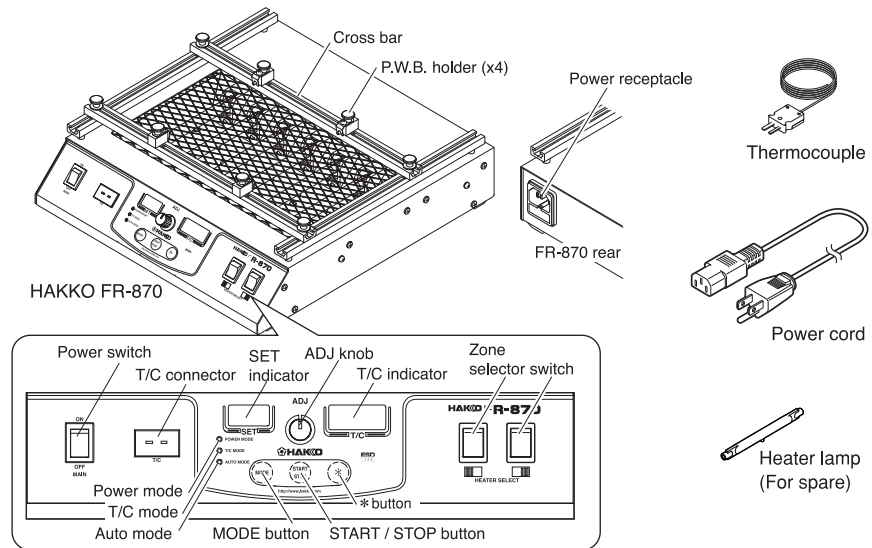

2. SPECIFICATIONS

Power consumption	100V-460W 110V-520W 120V-580W 220V-470W 230V-500W
Dimensions	290(W) × 100(H) × 308(D) mm
Weight (w/o cord)	3.4kg
Mode	Power mode 0~100% T/C mode 50~200°C (122~392°F)

* This product is protected against electrostatic discharge.
* Specifications and design are subject to change without notice.

■ Electrostatic Protection

This product includes such features as electrically conductive plastic parts and grounding of the handpiece and station as measures to protect the device to be soldered from the effects of static electricity. Be sure to observe the following instructions:

1. The handle and other plastic parts are not insulators, they are conductors. When making repairs or replacing parts, take sufficient care not to expose live electrical parts or damage insulation materials.
2. Be sure to ground the unit during use.

中國RoHS: 產品中有毒有害物質或元素的名稱及含量

部件名稱	有毒有害物質或元素					
	鉛(Pb)	汞(Hg)	銅(Cd)	六價鉻(Cr(VI))	多溴聯苯(PBB)	多溴二苯醚(PBDE)
電路板	×	○	○	○	○	○
水平支架	×	○	○	○	○	○
連接器	×	○	○	○	○	○
插座	×	○	○	○	○	○

○ : 表示該有毒有害物質在該部件所有均質材料中的含量均在SJ/T 11363-2006標準規定的限量要求以下。
× : 表示該有毒有害物質至少在該部件的某一均質材料中的含量超出SJ/T 11363-2006標準規定的限量要求。

3. WARNINGS, CAUTIONS AND NOTES

⚠ WARNING

Warnings, cautions and notes are placed at critical points in this manual to direct the operator's attention to significant items. They are defined as follows:

- ⚠ **WARNING:** Failure to comply with a WARNING may result in serious injury or death.
- ⚠ **CAUTION:** Failure to comply with a CAUTION may result in injury to the operator, or damage to the items involved. Two examples are given below.

NOTE: A NOTE indicates a procedure or point that is important to the process being described.

⚠ CAUTION

When powered, the preheater unit will become extremely hot, reaching a maximum temperature of 200°C (392°F). Be sure of the following to avoid possible burns/fires resulting from the failure to observe them.

- Do not touch the lamp cover. Also, do not place a metal object around the lamp cover.
- Do not use the product near an object that may readily catch fire.
- Inform all individuals nearby that the "product can be extremely hot and can pose a hazard."
- Turn off the product when suspending/terminating its operation or before leaving it unattended.
- Turn off the product and check to be sure it has sufficiently cooled before replacing a part or storing the product.
- This appliance is not intended for use by persons (including children) with reduced physical, sensory or mental capabilities, or lack of experience and knowledge, unless they have been given supervision or instruction concerning use of the appliance by a person responsible for their safety.
- Children should be supervised to ensure that they do not play with the appliance.

● To prevent accidents or damage to the HAKKO FR-870, be sure to observe the following:

- Do not use the product for purposes other than preheating.
- Do not subject the product to excessive impact.
- Do not expose the heater unit to hot air directly from above.
- Be sure that the product is properly grounded before use.
- Do not modify the product.
- Be sure to use genuine HAKKO parts for replacement.
- Be sure the product does not wet. Do not handle it with wet hands.
- Be sure to hold the plug whenever connecting/disconnecting the cord.
- Avoid any use or actions acts that could pose a hazard.

4. INITIAL SETUP

A. Making connections and turning on the power

1. Connect the power cord to the power receptacle found on the rear of the preheater body.
2. Connect the power plug to the power outlet.
3. Turn on the zone selector switch.

⚠ CAUTION

If pressing the START/STOP button with the zone selector switch both turned off, the display might indicate a heater error. When this occurs, turn on the zone selector switch, then turn the power switch on again.

4. Turn on the power switch.

B. Mounting the P.W.B.

Fit the P.W.B. to the FR-870. (Figure 1)

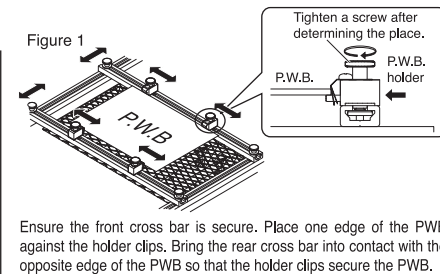

Ensure the front cross bar is secure. Place one edge of the PWB against the holder clips. Bring the rear cross bar into contact with the opposite edge of the PWB so that the holder clips secure the PWB.

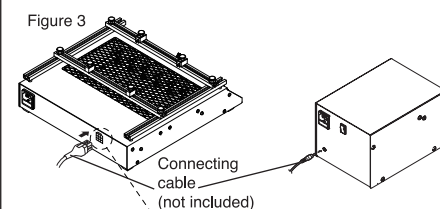
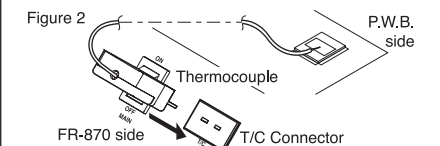

C. Attaching the thermocouple in t/c (auto) mode

Insert the thermocouple in the thermocouple connector; then, bring the tip of the thermocouple into contact with any location where you want to take measurements or a part you want to heat. (Figure 2)

⚠ CAUTION

Insert the thermocouple properly in the thermocouple connector, then, turn on the power switch again.

■ Connection with HAKKO FR-803B

HAKKO FR-803B can be connected to HAKKO FR-870 with connecting cable, which permits HAKKO FR-803B to be used along with HAKKO FR-870.

⚠ CAUTION

Connect HAKKO FR-870 and FR-803B by the connecting cable before turning on the power switch.

● START

When pressing the HOT AIR button of HAKKO FR-803B handpiece, HAKKO FR-870 will work in conjunction with HAKKO FR-803B. HAKKO FR-870 and FR-803B will be operated by the setting and mode of each unit.

NOTE:

When pressing the START/STOP button of HAKKO FR-870, Only HAKKO FR-870 will be activated.

● STOP

Press the HOT AIR button of HAKKO FR-803B handpiece or turn off the power when the profile is finished in auto mode.

⚠ CAUTION

When the HAKKO FR-870 is not activated while HAKKO FR-803B is activated, it will reversely gets activated. When FR-803B stops, press the START/STOP button to stop.

Please refer to the HAKKO FR-803B instruction manual for its use.

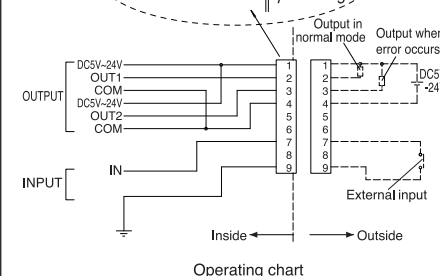

5. OPERATION

A. Selecting the desired mode

Use the MODE button to select the desired mode. (See Table 1 for checking the status of the lamps corresponding to individual modes.)
Normal modes: Select the appropriate normal mode if you want to control the preheater by setting only the output/temperature.
Auto modes: Select the appropriate auto mode if you want to control the preheater using a specific profile setting (e.g., output/temperature, time).

⚠ CAUTION

- If the preheater is used in combination with a hot air rework station, be sure the heater is not exposed directly to the hot air.
- Do not look directly at the heater lamp for a long time when power is on. Doing so may cause affecting the eyes.

Normal modes

● Power mode

LED lamp : POWER MODE

SET indicator and T/C indicator is shown in right illustration.

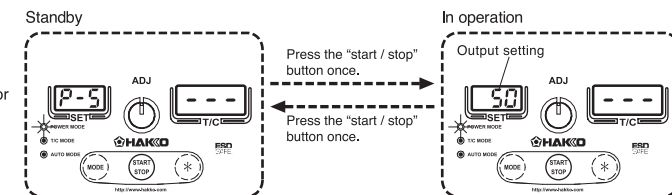

● T/C mode

LED lamp : T/C MODE

SET indicator and T/C indicator is shown in right illustration.

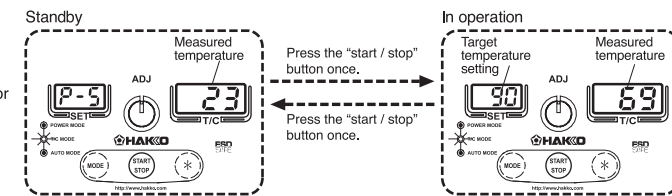

■ Auto mode

In auto modes, the preheater automatically returns to its previous state when all associated operations are completed. The unit will return to standby even when pressing the START/STOP button during operation.

● Power auto mode

The output (%) and time (sec) are controlled according to the profile set in 3 steps.

LED lamp : POWER MODE
AUTO MODE

SET indicator and T/C indicator is shown in right illustration.

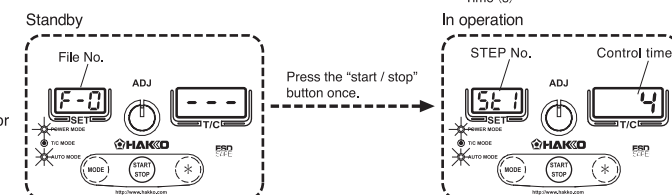

● T/C Auto Mode

The thermocouple is used to control the temperature of a specific location of measurement for a specific length of time according to the profile set in 3 steps.

LED lamp : T/C MODE
AUTO MODE

SET indicator and T/C indicator is shown in right illustration.

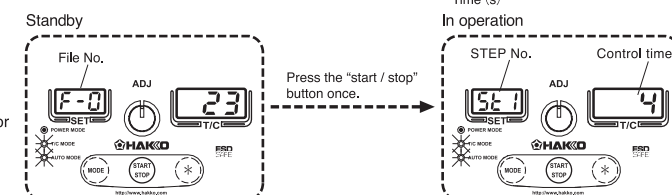

If the thermocouple is attached to the T/C connector while the preheater is in power mode/power auto mode, temperature readings are indicated on the T/C indicator for monitoring; otherwise, the symbol " --- " will be indicated.

B. Changing the settings used in normal mode

Changing the settings used in power mode

Be sure that the setting in power mode is between 0% and 100%.

- Initially, the setting is 50%.

EX: To change from 25% to 50%,

1. Hold down the (*) button found on the front panel for at least one second. The SET indicator flashes to indicate the current setting.

2. Changing the Setting

Turn the ADJ knob until the desired setting is indicated. When the desired setting is indicated, press the (*) button to complete the task.

NOTE : You can change the setting while the preheater is in operation.

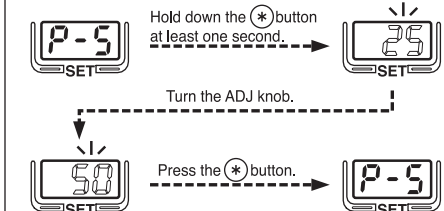

5. OPERATION

Changing the setting used in t/c mode

Be sure that the setting used in T/C mode is between 50°C and 200°C (122°F to 392°F)

- Initially, the setting is 100°C (212°F).

EX: To change from 50°C (122°F) to 125°C (257°F),

- Hold down the **(*)** button found on the front panel for at least one second.
The SET indicator flashes to indicate the current setting.

2. Changing the Setting

Turn the ADJ knob until the desired setting is indicated. When the desired setting is indicated, press the **(*)** button to complete the task.

D. Changing the file used in auto modes

Each file (indicated as F-0 through F-9) used in auto modes permits the specification of 10 profile settings. Before selecting a different file, be sure that the preheater is in auto mode (i.e., the AUTO MODE lamp is on).

- Hold down the **(*)** button found on the front panel for at least one second.
The SET indicator flashes to indicate the current setting.

2. Changing the Setting

Turn the ADJ knob until the desired setting is indicated. When the desired setting is indicated, press the **(*)** button to complete the task.

E. Changing the settings used in auto modes

Changing the Settings Used in Power Auto Mode

Table 1 Indications of Profile Nos.

Setting	Setting	Setting
P-1, STEP1 Power (%)	P-3, STEP2 Power (%)	P-5, STEP3 Power (%)
P-2, STEP1 Time (s)	P-4, STEP2 Time (s)	P-6, STEP3 Time (s)

- Hold down the **(MODE)** and **(*)** buttons found on the front panel simultaneously for 1 sec or more.
The SET indicator flashes to indicate the profile number while the T/C indicator indicates the current setting.

The SET indicator flashes to indicate the profile number while the T/C indicator indicates the current setting.

- Select the profile No. you want to edit.

Turn the ADJ knob until the desired profile No. is indicated. (For the profile setting corresponding to each profile No., see Table 1.) When the **(*)** button is pressed, the T/C indicator flashes to permit changing the set value.

- Edit the profile settings as necessary.

Turn the ADJ knob to edit the setting used in each STEP indicated on the flashing T/C indicator.

- When the setting change is completed, hold down the **(*)** button until the display reads "u".

When "u" is indicated on the SET indicator and the **(*)** button is pressed, the preheater returns to its standby state (i.e., to end the task).

Changing the settings used in t/c auto mode

Table 2 Indications of Profile Nos.

Setting	Setting	Setting
t-1, STEP1 Temp (C/F)	t-3, STEP2 Temp (C/F)	t-5, STEP3 Temp (C/F)
t-2, STEP1 Time (s)	t-4, STEP2 Time (s)	t-6, STEP3 Time (s)

- Hold down the **(MODE)** and **(*)** buttons found on the front panel simultaneously for 1 sec or more.
The SET indicator flashes to indicate the profile number while the T/C indicator indicates the current setting.

The SET indicator flashes to indicate the profile number while the T/C indicator indicates the current setting.

- Select the profile No. you want to edit.

Turn the ADJ knob until the desired profile No. is indicated. (For the profile setting corresponding to each profile No., see Table 2.) When the **(*)** button is pressed, the T/C indicator flashes to permit changing the set value.

- Edit the profile settings as necessary.

Turn the ADJ knob to edit the setting used in each STEP indicated on the flashing T/C indicator.

- When the setting change is completed, hold down the **(*)** button until the display reads "u".

When "u" is indicated on the SET indicator and the **(*)** button is pressed, the preheater returns to its standby state (i.e., to end the task).

NOTE :
You can change the setting while the preheater is in operation.

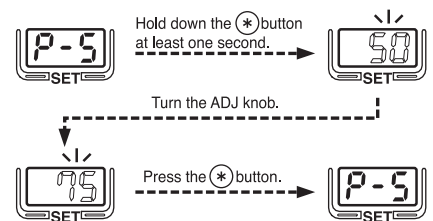

CAUTION
The control mechanism will not function properly if the sensor is mounted in an inappropriate location (i.e., area away from heat), possibly resulting in preheater operation failure. Be sure to take extra care when deciding on the sensor location.

EX: To switch from file No. 0 to file No. 3,

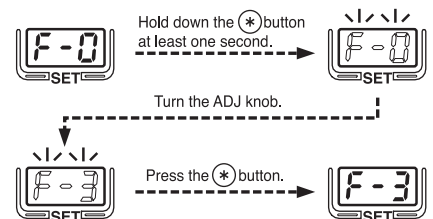

EX: To change the control time in STEP 2 from 5 sec to 7 sec,

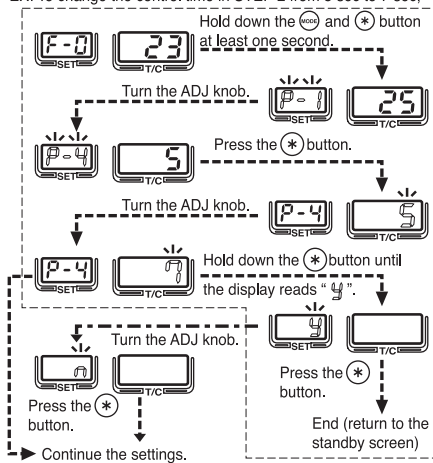

You can edit the settings as many times as you need until all settings are as you desire. If the power is removed while settings are being edited, the previous settings will remain valid.

EX: To change the control time in STEP3 from 5 sec to 3 sec

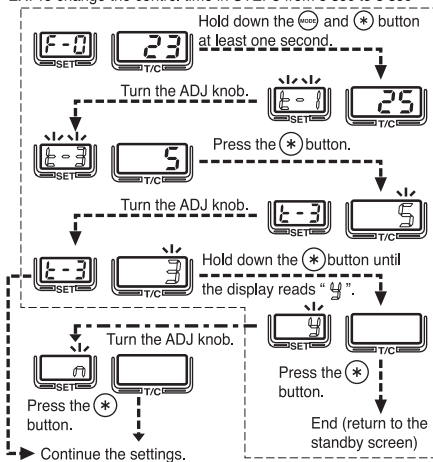

You can edit the settings as many times as you need until all settings are as you desire. If the power is removed while settings are being edited, the previous settings will remain valid.

6. PARAMETER SETTINGS

Table 3 Parameters and Their Settings

Parameter	SET indicator	T/C indicator	Setting	Initial setting
°C /°F switchover	01	1 or 2	1 : °C 2 : °F	1 (2**)
Temperature upper limit	02	3-digit value (0~537°C / 32~999°F)	Temperature upper limit alert	537 (999**)
Temperature lower limit	03	3-digit value (0~537°C / 32~999°F)	Temperature lower limit alert	0 (32**)
Auto shutoff	04	2-digit value (0~30min)	Shutoff time	0
Heater power alert time	05	2-digit value (0~30min)	Heater power alert time	0
Protection level	06	C-1 / C-2 / C-3	Protection level	C-1

* For the particulars of protection levels, see Table 5.

** For U.S.A.

Particulars of Parameters

°C /°F switchover function

Permits selection of either Celsius or Fahrenheit temperature indication.

Temperature upper limit alert function

Turns on the upper limit temperature alert to stop heater control if the temperature rises above the upper limit after reaching its predetermined level.

Temperature lower limit alert function

Turns on the lower limit temperature alert to stop heater control if the temperature drops below the lower limit after reaching its predetermined level.

Auto shutoff function

Stops heater control after a specific period of time following the start of control. The auto shutoff function will not operate if the timer is set to 0.

Heater power alert function

Turns on the heater power alert to stop heater control if the temperature fails to reach the predetermined level after a specific period of time following the start of control. The heater power alert function will not operate if the timer is set to 0.

Table 4 Protection Levels and Particulars of Protection

Protection level	Setting
C-3	Permits only the START/STOP operation.
C-2	In addition to C-3 operation, permits setting the output (temperature) and changing auto mode settings.
C-1	In addition to C-2 operation, permits switching modes.

Editing the Parameters

- Turn on the power while holding down the MODE button.

SET indicator: Indicates parameter Nos.

T/C indicator: Indicates parameter settings.

You can change the item on the flashing indicator.

- Select the desired parameter No.

See that the parameter No. on the SET indicator is flashing while the parameter setting on the T/C indicator remains on. Turn the ADJ knob to select the desired parameter No., and press the **(*)** button to confirm the change.

- Edit the parameter setting.

When you have selected the desired parameter No., the flashing moves from the SET indicator to the T/C indicator. Turn the ADJ knob to edit the parameter setting, and press the **(*)** button to accept.

- Save the change.

When you have finished changing all parameters you want to change, hold down the **(*)** button for a while (possibly at the end of 2. or 3.). When "u" is indicated on the SET indicator, press the **(*)** button once again to end the task and return the preheater to a standby state.

EX: To set the auto shutoff time to 15 min

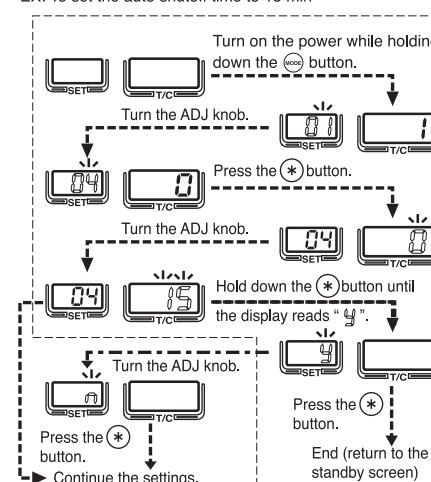

7. MAINTENANCE

In order for you to use the preheater in optimum condition for a long time, it is important that you perform maintenance work on a regular basis. The degree of wear and tear the preheater may incur varies depending on the temperatures it is used at and the environment it is used in. Provide appropriate care according to the conditions of its use.

WARNING

Exercise sufficient care, as the product becomes extremely hot. Unless otherwise instructed, be sure to turn off the power and disconnect the power cord before starting the work.

1. Cleaning the Reflector

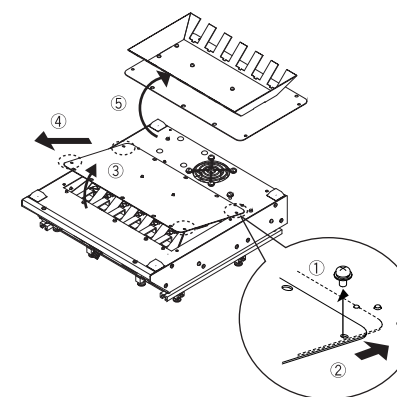

- Turn over the preheater body. (Place it in such a way that it remains stable throughout the work.)

- Remove the 4 screws used to fix the bottom plate in place.

- Hold the bottom plate, and detach it together with the reflector from the preheater body.

CAUTION

- Separate the part at an angle. It will not come off when pulled straight.
- Take care to avoid contact with the heater lamp and the wiring.

- Remove the dirt using alcohol.

CAUTION

- Use a soft cloth or the like to remove the dirt while taking care not to damage the reflector.
- Do not use powerful chemicals or the like to clean the reflector or scrape it with a tool.
- If the damage or dirt is excessive and does not permit cleaning, replace the reflector.

- Put the reflector back in place by reversing the foregoing steps.

8. Inspection

Burned-out heater lamp

Figure 4



Replacing the heater lamp

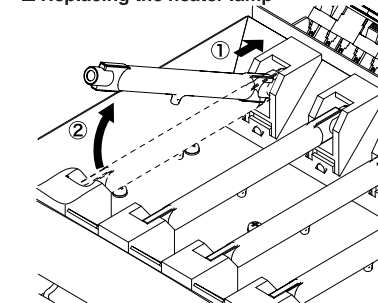

Measure the resistance of the heater. Measure the resistance across the segment indicated in Figure 4. If the heater lamp has an open circuit, replace the lamp.

- Remove the screws from the both sides of the unit and detach the cover.

- Turn over the heater lamp cover and detached it.

CAUTION

- Do not remove the nuts securing the grounding strap to the heater lamp cover.

- Replace the heater lamp.

CAUTION

- Do not subject the heater lamp to excessive impact.
- Do not hold the lamp by its glass portion at the center with bare hands.
- For replacement, hold the end of the lamp, and detach it from the socket at an angle.

- Put the lamp back in place by reversing the foregoing steps.

CAUTION

- Mount the lamp so that the sealing at the center faces downward (on the reflector side).
- Be sure that the grounding wire of the lamp cover is properly connected.

Replacing the Fuse

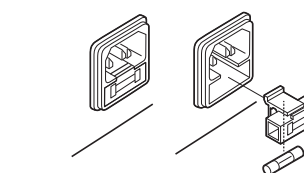

- Disconnect the power cord from the power receptacle.

- Pull out the fuse holder.

- Replace the fuse with a new one.

- Put the fuse holder back in place.

9. TROUBLESHOOTING

⚠ WARNING

Be sure to disconnect the power plug before inspecting the inside of the preheater or replacing its part to avoid electric shocks.

- The unit does not operate when the power switch is turned on.

CHECK : Is the power cord or the power plug disconnected?
ACTION Connect the cord or the plug.

CHECK : Has the fuse blown?

ACTION Find out why the fuse has blown; then, replace the fuse. If the fuse blows once again, ship the preheater body together with the fuse for necessary repairs.

- The heater lamp is not powered.

⚠ CAUTION

A single block has a set of 3 heaters. Keep in mind that an open circuit in one heater deprives the other heaters in the same block of power.

CHECK : Has the START/STOP button been pressed?

ACTION Press the START/STOP button.

CHECK : Is the selector switch off?

ACTION Turn on the selector switch.

CHECK : Is the heater lamp out of the socket?

ACTION Fit the heater lamp properly in the socket.

CHECK : Is the heater lamp burned out?

ACTION If the result indicates that the lamp has burned out, replace it.

- S-E is indicated.
(in T/C mode, T/C auto mode)

CHECK : Is the thermocouple connected to the preheater body?

ACTION Connect the thermocouple to the preheater body.

CHECK : Does the thermocouple have an open circuit?

ACTION If feasible, correct the open circuit; otherwise, replace the thermocouple.

- H-E is indicated.
(in T/C mode, T/C auto mode)

CHECK : Is the selector switch off?

ACTION Turn on the selector switch.

CHECK : Is the heater lamp burned out or out of place?

ACTION See "● The heater lamp is not powered."

CHECK : Is the setting for the heater power alert too low (set to too short a time)?

ACTION Change the heater power alert to an appropriate setting.

CHECK : Is the location of measurement for the thermocouple inappropriate or is the thermocouple mounted improperly?

ACTION Mount the thermocouple to an appropriate location of measurement.

- O-E is indicated
(in T/C mode, T/C auto mode)

CHECK : Is the setting for the temperature upper limit too low?

ACTION Change the temperature upper limit to an appropriate setting.

- U-E is indicated.
(in T/C mode, T/C auto mode)

CHECK : Is the setting for the temperature lower limit too high?

ACTION Change the temperature lower limit to an appropriate setting.

- The heater fails to exert control, the control mechanism is not normal, or the temperature indication remains unchanged.

CHECK : Is the thermocouple displaced from the location of measurement or is it mounted improperly?

ACTION Mount the thermocouple in an appropriate location of measurement.

- Settings cannot be edited. The mode cannot be changed.

CHECK : Is the protection level C-2 or higher?

ACTION By referring to "● Editing the Parameters," change the protect level to one that permits changing of the settings.

10. ERROR MESSAGES

All error indications occur only in T/C mode or T/C auto mode.

- Sensor error

S-E

S-E is indicated when the thermocouple is not properly connected to the preheater body or has an open circuit.

- Heater error

H-E

H-E is indicated when the selector switch is off or the heater lamp has burned out or is detached from the preheater body. H-E is also indicated when the heater power alert goes on.

- Temperature upper limit setting error

O-E

O-E is indicated when the temperature rises above the predetermined upper limit for some reason after it has stabilized during preheating.

- Temperature lower limit setting error

U-E

U-E is indicated when the temperature drops below the predetermined lower limit for some reason after it has stabilized during preheating.

⚠ CAUTION

All error indications will remain until the preheater is turned off and then back on.

11. PARTS LIST

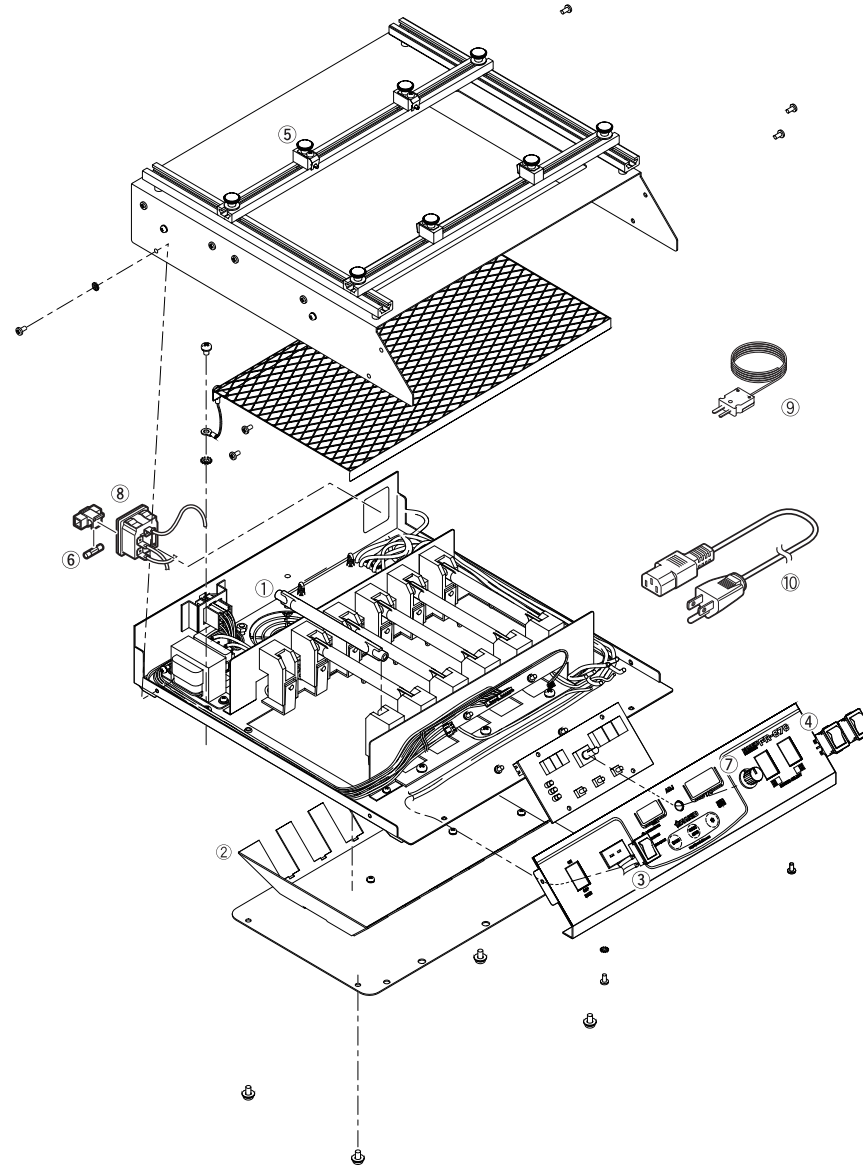

● HAKKO FR-870

Item No.	Part No.	Part Name	Specifications
①	A1574	Heater lamp	100-120V
	A1575	Heater lamp	
②	B3654	Reflector	
③	B3655	Switch	
④	B3656	Switch	For zone selector
⑤	B3658	P.W.B. holder	
⑥	B3527	Fuse	250V-10A
⑦	B1904	Knob	
⑧	B2384	Power receptacle	
⑨	B3516	Thermo couple	

Item No.	Part No.	Part Name	Specifications
⑩	B2419	Power cord, 3-wire cord & American plug	120V USA
	B2422	Power cord, 3-wire cord & BS plug	India
	B2424	Power cord, 3-wire cord & European plug	230V CE
	B2436	Power cord, 3-wire cord & Chinese plug	China
	B3508	Power cord, 3-wire cord & American plug	
	B3550	Power cord, 3-wire cord & SI plug	
	B3616	Power cord, 3-wire cord & BR plug	

● Optional parts

Item No.	Part No.	Part Name	Specifications
①	B3657	Connecting cable	

